

# VESSEL

STATIC ERASER TOP FAN

## Instruction Manual

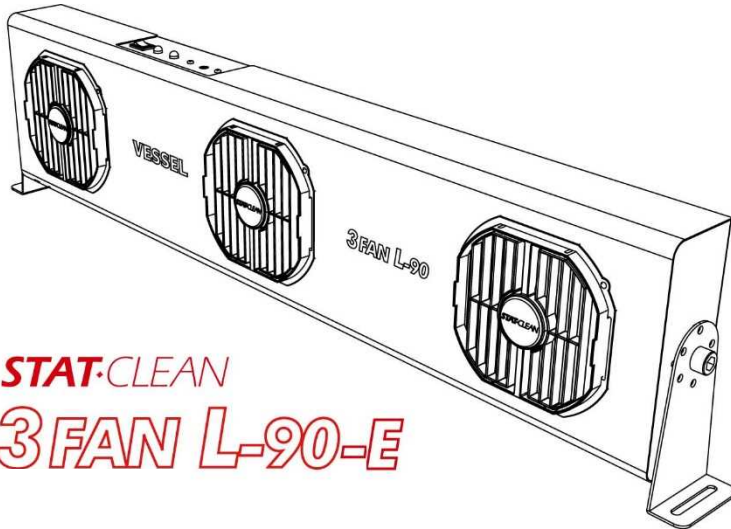

## **STAT-CLEAN** **3 FAN L-90-E**

Thank you for having purchased Stat Clean No. L-90-E  
Read this instruction manual carefully before use. Keep it in a safe handy place for future reference.

### **Table of Contents**

■For Your Safety .....	P.16
■Product Features .....	P.17
■Specifications .....	P.18
■External View .....	P.19
■Performance .....	P.20
■Installation .....	P.21
■Before Use .....	P.22
■Operation .....	P.23
■Maintenance .....	P.24
■Troubleshooting .....	P.27
■Storage .....	P.27
■Warranty .....	P.28

## ■ For Your Safety

### Safety Precautions

- Carefully read these Safety Precautions before use. Observe the precautions indicated herein to ensure safety.
- Safety precautions in this instruction manual are categorized into two types by the degree of danger associated with each of the followings. Based on danger analyses performed by Vessel, all precautions in this instruction manual are of the CAUTION level.
- If the equipment is used in a manner not specified by the manufacturer, the protection provided by the equipment may be impaired.

 **WARNING** Indicates that improper handling can lead to serious injury or even death.

 **CAUTION** Indicates that improper handling can lead to minor injury and property damage.

 This symbol indicates a WARNING or CAUTION.

 This symbol indicates a prohibited action.

 This symbol indicates a mandatorily required action

### CAUTIONS

 **PROHIBITED** Do not use L-90-E in environments that require explosion-proofing. L-90-E is not of explosion-proof construction, therefore explosion or fire may occur.

 **PROHIBITED** Do not use L-90-E in flammable atmospheres. The corona discharge can act as an ignition source and cause an explosion or fire.

 **PROHIBITED** Do not use L-90-E in environments subjected to sharp temperature fluctuations or dewing. This kind of environment can lead to breakdown.

 **DO NOT WET** Do not use L-90-E in highly damp places or anywhere it may be wet by water, oil, solvent or other liquid. Contact with moisture can result in electric shock or breakdown.

 **PROHIBITED** Do not use L-90-E for anything other than static erasure or dust removal.

 **PROHIBITED** Do not use L-90-E with power supplies of ratings not specified in the specifications. Inappropriate power supplies can result in fire and electric shock.

 **PROHIBITED** Do not install, use or service L-90-E until having understood the information in this instruction manual.

 **REMEMBER** Keep this instruction manual in a safe handy place for future reference.

 **CAUTION** VESSEL assumes no responsibility whatsoever for consequences arising from the use of this product.

### ■ AC-TYPE CORONA DISCHARGE

Alternating current discharge will prevent performance deflation especially for ion balance from affection of dust / contamination on the electrode. Independently mounted triple high voltage transformers generate ions with minimal re-bonding losses. Electrodes are capacitive coupling. That realize epic "No Adjustment Required" feature. High precision ion balancing within +/-10V.

### ■ FAN-TYPE STATIC ELECTRICITY ERASER

Triple 120 mm radius DC fans with front louver which can adjust wind area (straight / wide-angle) have step-less fan speed adjuster. Compact and light weight form factor ideal for wall / ceil mount. Two-way bracket (mounting bracket / desktop stand) and DC 24V power supply included. Expandable air filters (as standard accessory).

### ■ SAFETY ORIENTED DESIGN

To prevent electrical shock, the circuit is cut off and the power turns off when the front cover is taken off. Lesser Ozone: Due to discharge design of efficient Ion output, extremely little ozone is generated.

Monitor function is installed for fan motor malfunction and high voltage output error (LED indicators). In case of circuit short or overload condition is detected, high voltage transformer will be shut down automatically

### ■ Maintenance

No tools required to remove front louver and electrode units for easier maintenance. Electrode units are expandable.

### ■ EMI COUNTERMEASURES

Lower emission avoids affect on other electronic devices.

### Applications

Use to prevent trouble and dust adhesion caused by static electricity.

## ■ Specifications

---

### Specifications of the ionizing unit

Model	: L-90-E
Ion generation method	: High voltage AC corona discharge
Output voltage	: AC9.5kV(p-p)
Input voltage	: DC24V±5% 3A(max. )
Dimensions	: H182×W814×D91 (H201×W880×D91 including stand)mm
Weight	: 5.4 kg
Air Capacity	: LO 6.3 [CMM] HI 7.1 [CMM]
Noise emission	: LO 71.9 [dBA] HI 75.4 [dBA] (1m)
Ozone generation	: 0.05ppm or less (Measured at 50mm)
Warning output	: High voltage alarm (Red LED), stop due to fan lock (Red LED)
Protective function	: Fan motor rotation monitoring function (Detecting rotation lock) : High-voltage output shut down function (overload detection) : Power supply overcurrent protection (5A fuse on the substrate)
Working ambient temperature / humidity	: 5~40°C / 35~65%RH (No dewing)
Storage Temperature / humidity	: 0~60°C 35~85%RH (No dew condensation or freezing)
Distance from target area	: 150~900mm (Installation location: Non-dangerous indoor location)
Static electricity removal time	: Refers to the items in the performance chart.
Ion balance	: Within ±10 (At 300mm, at the time of factory shipment)
Air filter	: Sponge filter
Material	: Casing ... SPCC, : Stand ... Stainless steel : Front Cover... Flame-retardant ABS resin, : Electrode ... SUS304

### Accessories

· Adapter No.AD24-IT37E	
Rated input voltage	: AC100V-240V(50/60Hz) 1.5A
Rated output voltage	: DC24V 3.75A
Working temperature /humidity	: 0~40°C 10~85%RH (No dew condensation or freezing)
Cable length	: DC output cable: approx1.8m , AC input cable: approx.1.8m
Weight	: 350g
· Front Cover	: Straight Blowing Front Cover, Ion Diffusion Front Cover

### Expendables

Front Cover Electrode	: L-90CH	Filter	: L-90F
Filter set	: L-90FS		

\*The measurement values were obtained using the VESSEL measurement environment, so error could be induced depending on the operation environment.

## External view

### L-90-E

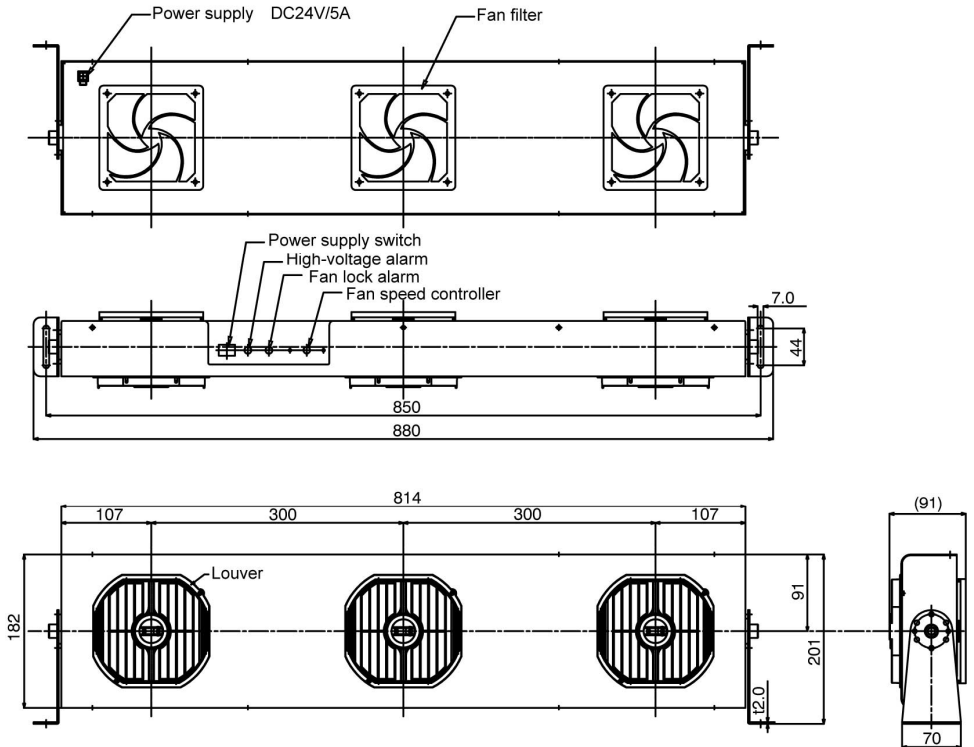

### AD24-IT37E

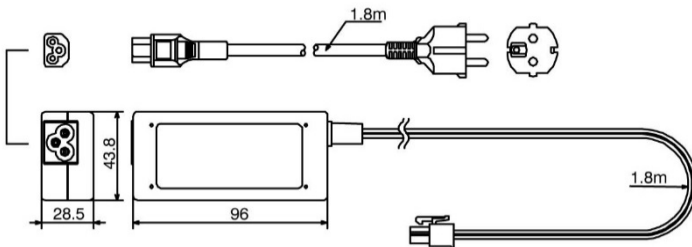

# ■ Performance

## Louver straight

	150	300	600	900 (mm)
450	-0.9 + 1.2 - 1.3	-1.4 + 2.0 - 2.4	1.2 + 2.8 - 3.7	0.2 + 3.4 - 4.9
300	0.1 + 0.7 - 0.7	-1.5 + 1.7 - 2.1	0.3 + 3.0 - 3.8	0.5 + 4.1 - 5.7
150	0.2 + 0.7 - 0.7	-3.9 + 1.2 - 1.6	1.9 + 2.5 - 2.6	1.9 + 3.8 - 4.8
0	3.4 + 0.8 - 0.8	5.4 + 2.0 - 2.4	2.1 + 2.6 - 3.3	3.1 + 3.4 - 4.9
150	2.4 + 0.7 - 0.8	5.3 + 1.1 - 1.2	3.0 + 2.0 - 2.6	1.1 + 3.1 - 4.6
300	0.8 + 0.9 - 1.0	4.1 + 2.2 - 2.7	3.0 + 3.4 - 3.9	2.3 + 3.6 - 4.9
450	5.3 + 1.4 - 1.4	3.8 + 1.7 - 2.0	1.8 + 3.4 - 4.6	2.8 + 3.9 - 5.4

## Louver wide-angled

	150	300	600	900 (mm)
450	0.6 + 16.1 - 17.2	0.4 + 14.8 - 16.8	2.8 + 12.4 - 18.1	2.8 + 9.4 - 15.8
300	-1.4 + 0.7 - 0.7	0.8 + 1.0 - 1.2	1.7 + 2.0 - 2.9	3.0 + 3.3 - 5.3
150	3.5 + 5.6 - 6.1	2.7 + 4.7 - 4.5	3.2 + 2.1 - 3.0	2.0 + 2.9 - 4.0
0	2.8 + 0.7 - 0.7	1.0 + 1.0 - 1.1	3.4 + 1.8 - 2.5	3.9 + 2.7 - 3.9
150	-1.1 + 2.8 - 3.7	2.2 + 2.2 - 2.8	2.8 + 2.7 - 2.9	3.9 + 3.3 - 4.3
300	3.4 + 0.8 - 0.8	2.4 + 1.1 - 1.5	3.6 + 2.7 - 3.8	3.9 + 5.2 - 6.2
450	-1.0 + 107.8 - 115.0	-0.2 + 47.7 - 57.7	2.8 + 15.8 - 22.1	3.4 + 11.6 - 19.2

\*BASED ON ANSI EOS/ESD S3.1 compliant CPM:TREK 158,  
Temperature :25°C, Humidity :50%

Top row: Ion Balance Value





Middle row: Decay time from +1000V to +100V (sec)

Bottom row: Decay time from -1000V to -100V (sec)

<Fan Speed: Hi>

\*The measured values are based on the data obtained through a series of experiments conducted in our laboratory. It is expected that the figures may vary to some extent depending on the environment.

## ■ Installation

 <b>CAUTIONS IN INSTALLATION</b>	
 <b>REMEMBER</b>	Use only the included power supply adapter. Use of other adapters may result in fire, electric shock and static electricity removal trouble.
 <b>REMEMBER</b>	Install L-90-E securely. L-90-E can be damaged or malfunctioned if it falls.
 <b>REMEMBER</b>	Install L-90-E based on below stated environment. Adverse environments cause product deterioration and breakdown. Humidity: 35~65%RH (No dewing) Temperature: 5~40℃
 <b>PROHIBITED</b>	Do not use L-90-E based on below stated environments. Adverse environments can result in explosion, fire, electric shock and accident. *Where explosion-proofing is required. *Where flammable atmospheres found. *Where temperature and humidity are outside specified ranges. *Where dewing or sharp temperature fluctuations occurs. *Where there is heavy dust or smoke. *Where possibly wet by water, oil, chemicals, etc. *Where strong electric or magnetic fields are generated.





### How to install









L-90-E can be installed to the ceiling, desktop, wall and other structures by the stainless steel stand, which is included as a standard equipment.

Before installing L-90-E, check the strength of supporting structure.

### When mounted on a wall or structure

- Select a location and height in consideration of L-90-E's static electricity removal range.  
(For information regarding the static electricity removal range, refer to the page of Performance.)
- Use the mounting holes in the bottom of the stand to secure it to the structure or cell base.  
(For the dimension drawing, refer to the exterior view drawings.)
- The angle can be adjusted using the adjustment screws located on the left and right sides of the stand (hexagon socket head bolt, width across flats 8m).  
Securely tighten the adjustment screws after adjustment.

 <b>CAUTIONS IN INSTALLATION</b>	
 <b>REMEMBER</b>	Keep objects from getting in-between L-90-E and the target area.
 <b>CAUTION</b>	Before installing L-90-E, check the strength of supporting structure.
 <b>REMEMBER</b>	Do not block up the filtering cover on the back of the units. Keep the unit at least 10 cm away from the wall.

 <b>CAUTIONS BEFORE USE</b>	
 <b>REMEMBER</b>	Use only the included power supply adapter. Use of other adapters may result in fire, electric shock and static electricity removal trouble.
 <b>REMEMBER</b>	If noticing anything strange, stop using L-90-E immediately.
 <b>PROHIBITED</b>	Do not use L-90-E for other purposes than static electricity removal.
 <b>PROHIBITED</b>	Do not remodel or disassemble L-90-E. L-90-E contains high voltage parts.
 <b>PROHIBITED</b>	Do not drop L-90-E or apply strong impacts.
 <b>PROHIBITED</b>	Keep L-90-E away from sources of heat.
 <b>PROHIBITED</b>	Do not test the electrode wires for grounding, short-circuiting or sparking. These tests can adversely affect ion balance.

### Daily Checks

Check L-90-E for inspection before use.

To check how to conduct inspection or maintenance on the unit, please refer to “Maintenance” (P.12).

### Connector connection

Insert the included dedicated AC adapter connector into the jack on the back of the body.

### AC adapter connection

Use the power adapter (AD24-IT37E) which is specifically designed for use of L-90-E.

The AC adapter plug is a 3-pronged plug.

Connect this to a power outlet that has a ground terminal.

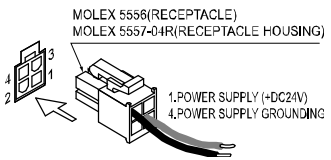
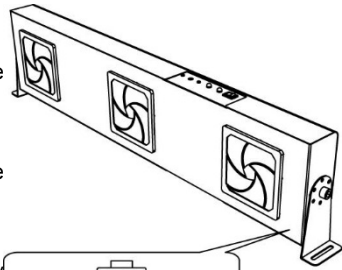



## ■ Operation

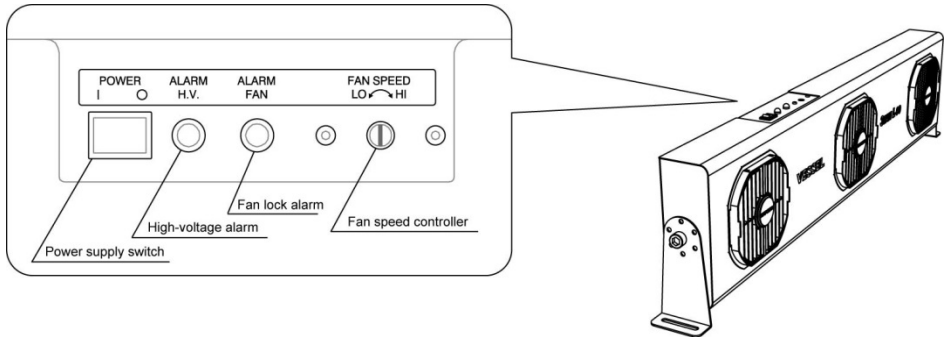

### POWER SUPPLY SWITCH

This is used to start and stop the unit.

When switched to [ I ], the power is turned on, the switch LED lights up, and operation starts.  
When switched to [ O ], the power is turned off and operation stops.

### FAN SPEED CONTROLLER

Step-less adjustment is used to adjust the fan speed.

Use a slotted screwdriver to make the adjustment.

The rotation range is 270 degrees. Forcing the screw any further may result the unit to damage.

### HIGH-VOLTAGE ALARM

If the piezoelectric transformer detects an overload and shuts down the operation, the high-voltage alarm lamp will light up.

When any of the alarm lamps lights,

- 1) Unplug the power cable immediately and remove it from the body.
- 2) Remove the front cover and inspect visually the electrode needles.  
If debris is adhered to the needles, refer to Cleaning Procedure and clean the needles.

### FAN LOCK ALARM

Fan lock alarm lamp lights when the fan motor stops rotating.

When fan lock alarm lamp lights,

- 1) Unplug the power cable, immediately and remove it from the body.
- 2) Remove the fan cover and visually inspect around the fan.  
\* If debris is adhered to the fan, remove the debris and switch on the power again and make sure that the lamp is off.  
\* If the alarm lamp comes on again, contact the supplier for servicing.





### Daily Checks

Check L-90-E for inspection before use.

- Dust on electrodes
- Dirty front guard
- Dirty filter
- Disconnected ground wire
- Damaged or loose parts
- Adhering condensation or water droplets

If damage or trouble is detected, contact the place of purchase for servicing.



### CAUTIONS IN MAINTENANCE AND CHECKS

 <b>DO NOT DISASSEMBLE</b>	Do not disassemble L-90-E. Servicing is reserved for service engineers.
 <b>UNPLUG POWER CABLE</b>	Before making checks, unplug the power cable. Working with the power on can result in electric shock and breakdown.
 <b>PROHIBITED</b>	Do not wipe L-90-E with detergent or solvent. It may cause cracking and result in electric shock or breakdown.
 <b>DO NOT WET</b>	Do not wet L-90-E. Contact with moisture can result in electric shock or breakdown.
 <b>CHECK</b>	Periodically check L-90-E. Failure of periodical inspection can result in early breakdown.

### Casing Cleaning

To clean the casing, wipe with a dry soft cloth. Suck up dust from openings with a vacuum cleaner.

### CAUTION

 <b>PROHIBITED</b>	Do not wipe it with solvents or cleaners, such as alcohol or paint thinner. It may cause cracking and result in electric shock or breakdown.
 <b>DO NOT WET</b>	Do not wet the L-90-E. Contact with moisture can result in electric shock or breakdown.

## ■ Maintenance

### When cleaning the front cover

After using for long hours, dust adhered to the front cover may lower the ionizing performance or cause dust to fly around. Please set periodical cleaning plan.

- 1) Be sure to turn the power switch to ○ to stop the operation.
- 2) Unplug the power supply adapter from the electrical outlet.
- 3) Remove the front cover.
- 4) Wipe it with a dry, soft cloth.
- 5) Reinstall the front cover.

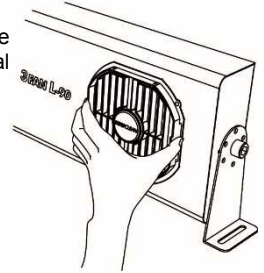

### ⚠ CAUTION

#### ● CLEANING

A dirty front cover could lower the static erasing performance or cause dust to fly around. Be sure to clean it as required by the operation environment.

### Electrode Needle Cleaning/Replacement

After using long hours, dust adhered around the electrode wires. Dust adhesion can lower the performance of ionizing. Clean the discharge needles every 100 hours at least.

- 1) Before cleaning the electrode wires, shut OFF power and unplug the power supply adapter from the electrical outlet.
- 2) Unplug the power supply adapter from the electrical outlet.
- 3) Lay the electrode wires on a cloth or mat not to damage while cleaning.
- 4) Remove the front cover.
- 5) Use a dry, soft cloth to wipe the tip of the discharge needles to remove accumulated dust.

**Be careful not to stick yourself on the needles.**

- 6) Attach the protection cover to L-90-E and connect the AC adapter. Make sure the front cover is securely installed.

If the cover is not installed correctly, the safety mechanism will operate causing the fan to stop.

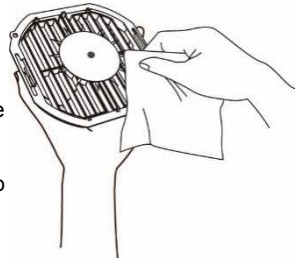

### ⚠ CAUTION

#### ● CLEANING

If the discharge needle is dirty, it could lower the static erasing performance or cause dust to fly around. Be sure to clean the contaminated parts according to your service condition.

### When replacing the discharge needle

If the static erasing performance does not recover even after cleaning, the discharge needle could be worn out.

Remove the discharge needle the same as for cleaning and replace it with a new one.

### ⚠ CAUTION

#### ⊘ PROHIBITED

If the knob of the electrode needle unit is broken or dropped out, stop the operation and replace it with a new one. It can lead to an electric shock or injury.

### When cleaning the filter

After being used for a long time, dust adhered to the filter could lower ionizing performance or cause dust to fly around. Periodically clean or replace the filter.

- 1) Before cleaning the filter, shut OFF power and unplug the power supply adapter from the electrical outlet.
- 2) Unplug the power supply adapter from the electrical outlet.
- 3) Remove the filter cover.
- 4) Remove and clean the filter. Make sure the filter is dry before reusing it. Installing the filter while still wet could damage the unit.
- 5) Dust will also be adhered to the outside and inside filter covers, so use a dry, soft cloth to wipe them off.
- 6) Reinstall the filter and reinstall the filter cover.

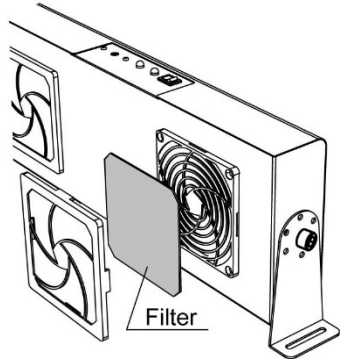

### ⚠ CAUTION

#### ● CLEANING

If the filter is dirty, it could lower the static erasing performance or cause dust to fly around. Be sure to clean the contaminated parts according to your service condition.

### When replacing the filter

If cleaning will not remove the debris from the filter, replace it with a new one.

Remove the filter cover with the same procedure as cleaning and then replace the filter.

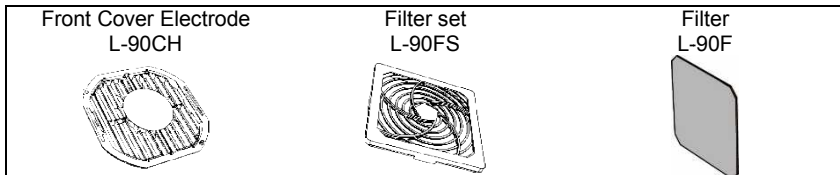

### Accessories



## ■ Troubleshooting

Using L-90-E in improper working condition may cause product damage or personal accident. Therefore, promptly request servicing if trouble occurs. For servicing, contact the supplier.

### CAUTION TROUBLESHOOTING

 <b>PROHIBITED</b>	<p>Do not use L-90-E in the following situations. It may result in fire or electric shock.</p> <ul style="list-style-type: none"> <li>* When L-90-E has been damaged because of dropping or shock</li> <li>* When air is not blowing through the power switch of the ionizer is ON position</li> <li>* When the power cable is damaged or hot</li> <li>* When the power supply adapter is loosely connected to the electrical outlet</li> </ul>
 <b>UNPLUG POWER CABLE</b>	<p>If trouble occurs with L-90-E, turn the power switch OFF and unplug the power cable.</p>
 <b>DO NOT DISASSEMBLE</b>	<p>Do not disassemble L-90-E.</p>

## ■ Storage

### Remember

In the following cases, contact the place of purchase for servicing.

**Do not service L-90-E by yourself as this can be dangerous.**

- If the power lamp does not light when the power switch is in the ON position.
- If the fan speed does not change even when the fan speed controller is modified.
- If the air blows or does not blow from the fan when moving the ionizer during operation.
- If the power cable or the power supply adapter is abnormally hot.
- If L-90-E emits strange noises or vibrates during use.
- If sparks are seen coming from electrode wire tips (In normal operation, sparks are not seen.)

### CAUTION STORAGE

 <b>PROHIBITED</b>	<p>Do not store L-90-E in the following places.</p> <p>Adverse environments can cause product breakdown.</p> <ul style="list-style-type: none"> <li>* Where exposed to vibrations or shock</li> <li>* Where temperature and humidity are outside specified ranges</li> <li>* Where dewing occurs</li> <li>* Where temperature fluctuates sharply</li> <li>* Where there is the possibility of ignition or explosion of flammable solvents, dust, etc.</li> <li>* Where there is heavy dust or smoke</li> <li>* Where possibly wet by water, oil, chemicals, etc.</li> <li>* Where strong electric or magnetic fields are generated</li> </ul>
---	---

## LIMITED WARRANTY:

VESSEL expressly warrants that for a period of one (1) year from the date of purchase, VESSEL static erasers will be free of defects in material (parts) and workmanship (labour). Within the warranty period, Defects occurring will be repaired or products will be replaced at VESSEL's option and expense, if VESSEL receives notice during the warranty period. Defective products must be returned to VESSEL Osaka Japan with proof of purchase date. And if your unit is out of warranty, VESSEL will quote repair charges necessary to ship your unit freight prepaid to where you have originally purchased.

## WARRANTY EXCLUSIONS:

THE FOREGOING EXPRESS WARRANTY IS MADE IN LIEU OF ALL OTHER PRODUCT WARRANTIES, EXPRESSED AND IMPLIED, INCLUDING FITNESS AND MERCHANTABILITY AND FITNESS FOR A PARTICULAR PURPOSE WHICH ARE SPECIFICALLY DISCLAIMED.

The express warranty will not apply to defects or damage due to accidents, neglect, misuse, alterations, operator error, or failure to properly maintain, clean, or repair products.

## LIMIT OF LIABILITY:

This electronic static eraser use high voltage corona discharge and should not be used in or near flammable or explosive environments. In no event will VESSEL or any seller is responsible or liable for any injury, loss or damage, direct or consequential, whether based in tort or contract arising out of the use of or the inability to use the product. Fulfillment of VESSEL's warranty obligations will be Customer's exclusive remedy and VESSEL's and Seller's limit of liability for any breach of warranty or otherwise. Before using this unit, users shall determine the suitability of the product for their intended use, and users assume all risk and liability whatsoever in connection therewith.

Model	L-90-E	
Warranty	(1) year from the date of purchase	
Customer	Name	
	Address	
	Tel. No.	
Dealer	Name/Address/Tel. No.	

## VESSEL Co., Inc.

17-25, Fukae-Kita 2-chome,  
Higashinari-ku, Osaka 537-0001 Japan  
Tel : +81 6 6976 7778 Fax : +81 6 6972 9441  
E-mail : export@vessel.co.jp  
URL : www.vessel.co.jp

Ver.4 Printed on 2019.11.05